



## 2" COIL SPRING / SHACKLE LIFT INSTALLATION INSTRUCTIONS CHEROKEE 1984-2001 KIT# JC240 KIT# JC240G (w/ Greasable Shackles)

### ⚠WARNING

Read and understand all instructions, warnings, cautions, and notes in this sheet and in your owners manual before you begin the installation of this coil lift kit.

### ⚠WARNING

Proper installation of a Performance Automotive Group coil spring lift kit requires knowledge of the factory recommended procedures for disassembly and assembly of original equipment components. We recommend that the factory shop manual and any special tools necessary to your vehicle be on hand during the installation. Installation of this coil lift kit without proper knowledge of the factory recommended procedures may affect the performance of these components and the safety of your vehicle. We strongly recommend that a certified mechanic familiar with the installation of similar components install this coil lift kit.

### ⚠WARNING

Ensure that your vehicle tires are properly blocked and secured before you begin installation of this coil spring lift kit.

### ⚠CAUTION

It is the customer's responsibility to ensure that all mounting hardware is correctly tightened before, during and after use of coil spring lift kit. DO NOT EXCEED manufacturer's load specifications for your vehicle. Always operate your vehicle in a safe manner. If your vehicle is equipped with any type of extra duty suspension or special towing package, this coil lift kit may not fit properly. If your vehicle is equipped with any type of aftermarket springs, lift kits, or bushings, this coil lift kit may not fit properly.

### ⚠WARNING

Many states now have laws restricting bumper heights and vehicle lifts. Local laws should be consulted to determine if the changes you intend to make to your vehicle comply with state laws. Before combining a body lift with a suspension lift, consult an installation professional to see how this will affect your specific application.

### ⚠WARNING

This coil spring lift kit should only be installed on vehicles in good working condition. Before installation, the vehicle should be thoroughly inspected for evidence of corrosion or deformation. This coil lift kit should not be installed on any vehicle that is suspected to have been in a collision or misused. Failure to observe this warning may result in serious personal injury and/or severe damage to your vehicle.

### ⚠WARNING

To ensure the Supplemental Restraint System (SRS, or air bag) is not accidentally deployed during coil / shackle lift kit installation, always ground yourself and the vehicle. Do not use power or pneumatic tools. Exercise extreme caution while working near SRS sensors and wiring. Do not allow anyone near air bags during kit installation. Accidental deployment can result in serious personal injury or death.

### ⚠WARNING

Always wear eye protection when operating power tools.

### ⚠NOTE

Performance Automotive Group recommends using the Loctite® supplied in the kit on all hardware unless noted in the instructions.

## A. Before you start.

### ⚠NOTE

Keep track of hardware quantity and position. Kit parts are prefaced by the word *kit* in italics.

1. Read all warnings and instructions completely and carefully before you begin.
2. Check to make sure the kit is complete (refer to the Parts List, Section F).
3. Special tools, such as coil spring compressors, are required for installation of this coil lift kit.
4. Only install this kit on the vehicle for which it is intended. If anytime during the installation you encounter something different from what is outlined in the instructions, call technical support at (928) 636-3175.
5. Park the vehicle on a clean, dry, flat, level surface and block the tires so the vehicle cannot roll in either direction.
6. Disconnect both battery cables.
  - a. Disconnect the negative cable (1) first, then the positive cable (2) from the battery (3).

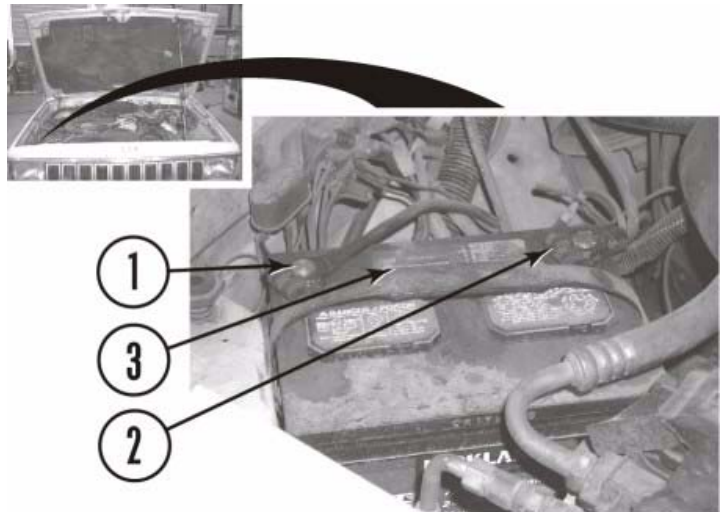

## B. Get ready to install front axle coil spring lifts.

1. Lift front axle.
  - a. Loosen five lug nuts (4) each from two front wheels (5).
  - b. Using a hydraulic jack, slowly lift front axle (6) so that two front tires (7) are three to five inches off of ground. Position jack stands under frame (8) just behind frame control arm perches (9). Lower frame onto jack stands. Do not remove hydraulic jack and maintain some hydraulic jack pressure on axle.
  - c. Remove five lug nuts (4) each and two front wheels (5) from axle (6).

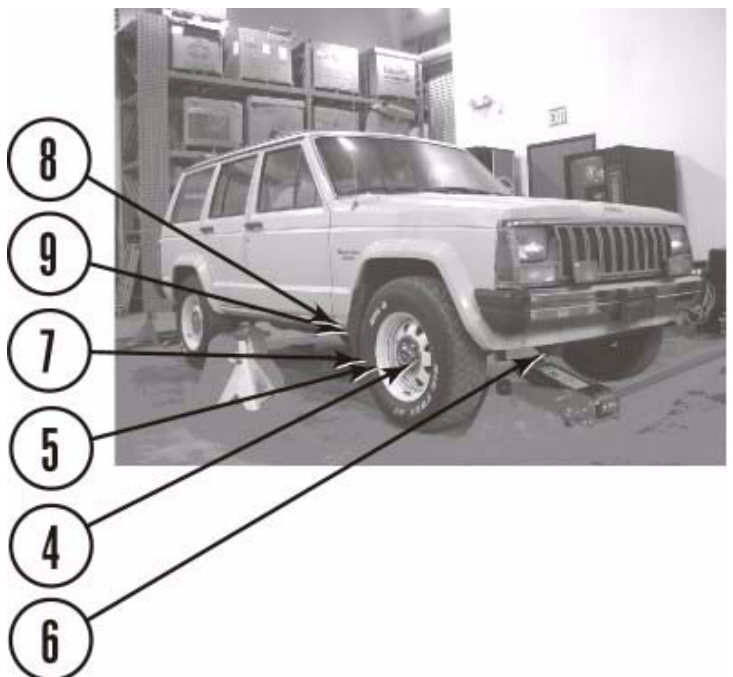

2. Remove front axle passenger side hardware.

- a. Remove two nuts (10) and bolts (11) from shock (12) and front axle (6).
- b. If present, remove bolt (13) and spring clamp (14) from front axle (6) and coil spring (15).

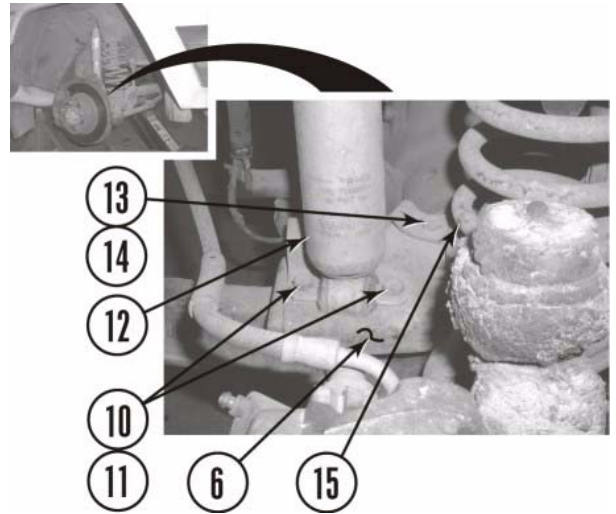

- c. Remove nut (16), washer (17), bushing (18), and sway bar (19) from sway bar link (20).

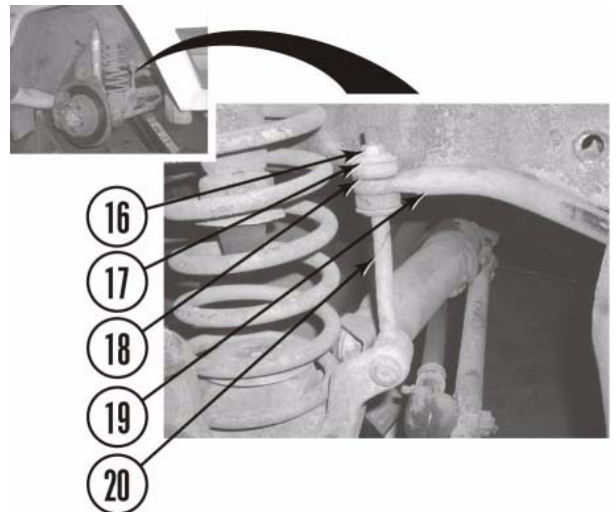

- d. Remove nut (21), bolt (22), and control arm (23) from frame control arm perch (9).

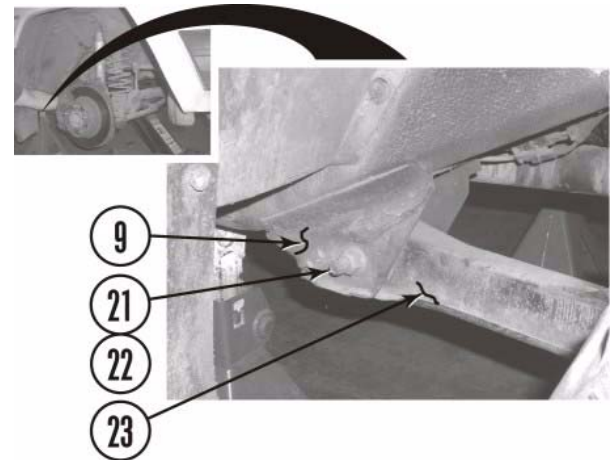

3. Remove passenger side coil spring.

- a. Push down on front axle (6) and remove coil spring (15) from axle and frame perch (24).

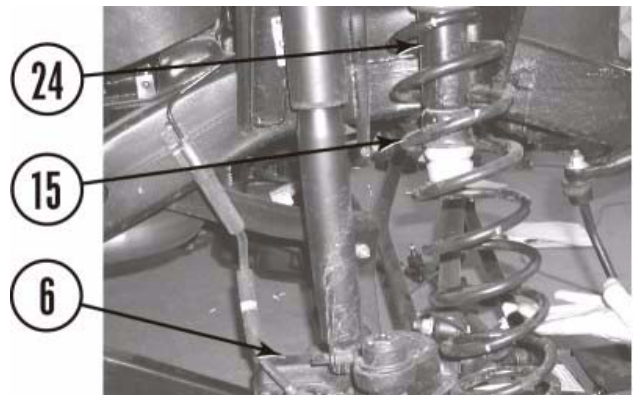

**NOTE**

On 84 - 86 model XJ's, the bump stop, bump stop cup, and bolt are a one piece unit. They are removed as one piece.

4. One piece bump stop removal

- a. Remove bump stop bushing (25) from frame perch (24).

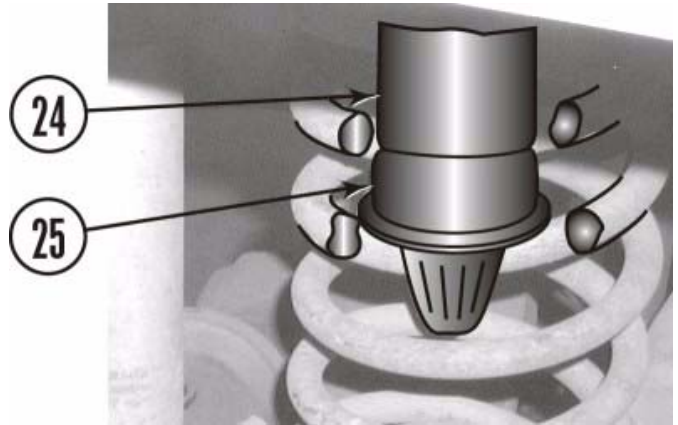

5. Three piece bump stop removal

- a. Remove bump stop bushing (26) from bump stop cup (27).

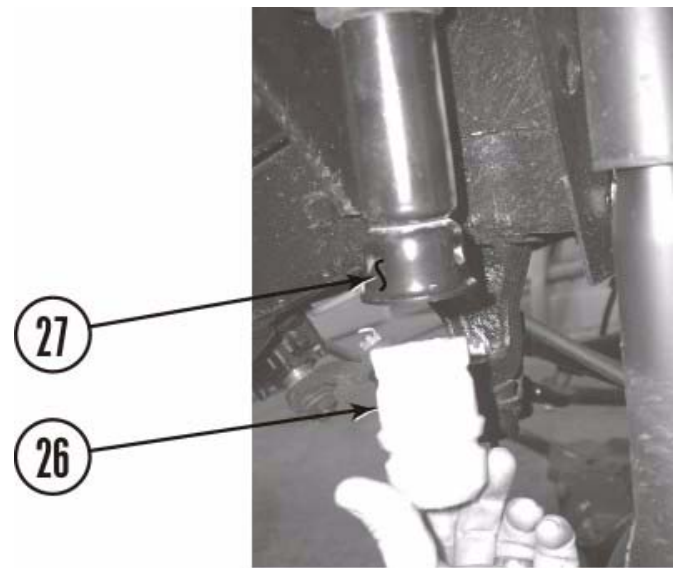

- b. Remove bolt (28) and bump stop cup (27) from frame perch (24).

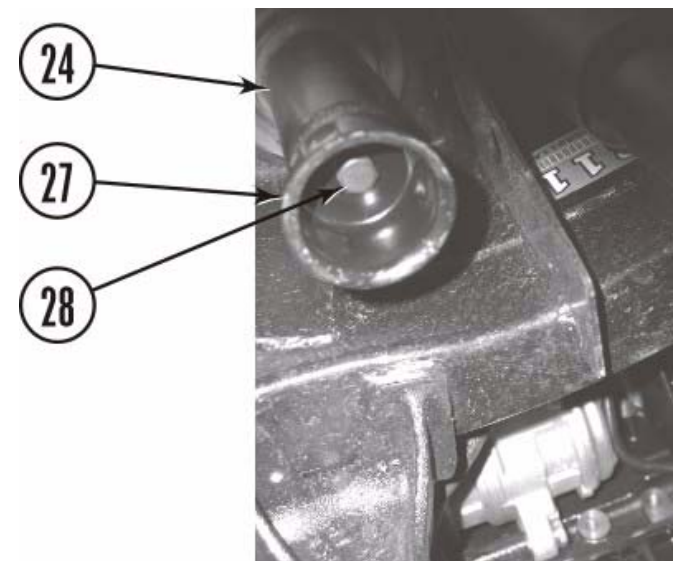

## C. Install the kit.

1. Install passenger side *kit* coil lift spacer.
  - a. Install *kit* coil spacer lift (29) on frame perch (24).

### ⚠NOTE

Performance Automotive Group recommends using Loctite® supplied in the kit for all mounting hardware.

### ⚠WARNING

Ensure that all OEM or aftermarket bump stops are installed. Suspension over travel can result in serious damage or failure of OEM components and aftermarket equipment.

2. Bump stop installation.
  - a. Coat threads of *kit* bump stop bushing (30) with Loctite®.
  - b. Install *kit* bump stop bushing (30) on frame perch (24).

### ⚠NOTE

Step B.3.a below, may require the use of coil spring compressors.

3. Install front axle passenger side hardware.
  - a. Position coil spring (15) on frame perch (24) and front axle (6).

### ⚠NOTE

Position of coil spring on axle is important. Ensure proper OEM alignment is maintained.

- b. If removed, install spring clamp (14) on front axle (6) and coil spring (15) with bolt (13).
- c. Install shock (12) on front axle (6) with two bolts (11), and nuts (10).
- d. Install sway bar (19) on sway bar link (20) with bushing (18), washer (17), and nut (16).

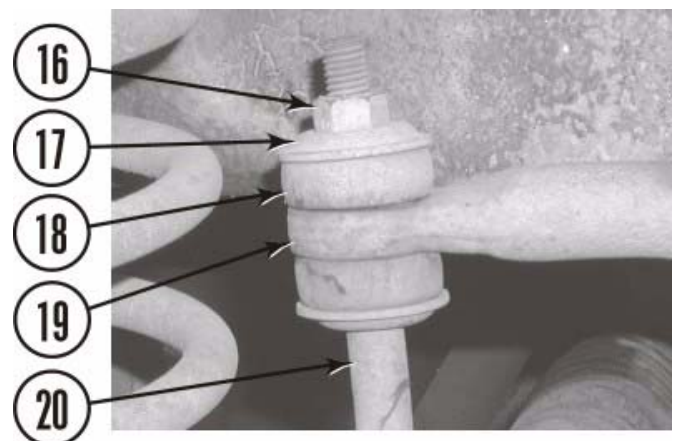
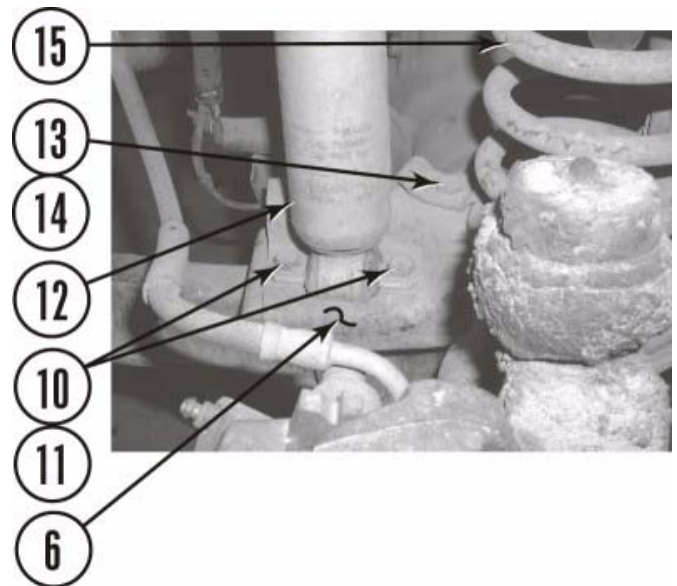
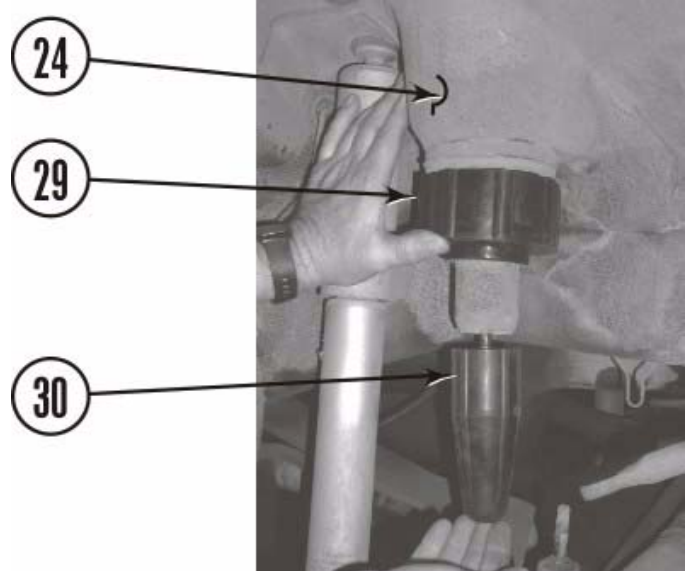

- e. Install control arm (23) on frame control arm perch (9) with bolt (22) and nut (21).
- f. Repeat steps B.2.a. through C.4.f. for frame driver side front axle (6).

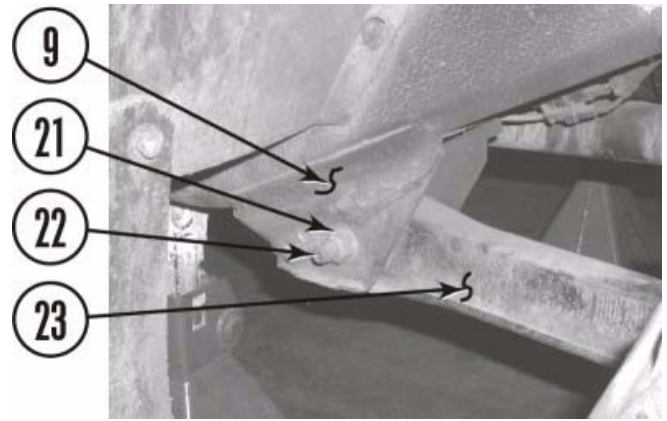

4. Finish front axle.

- a. Install two front wheels (5) on front axle (6) with five lug nuts (4) each.
- b. Using a hydraulic jack, slowly lift front axle (6) so that front tires (7) are three to five inches off of ground. Remove jack stands from frame (8). Lower vehicle to ground and tighten ten lug nuts (4) to manufacturers recommended specification.

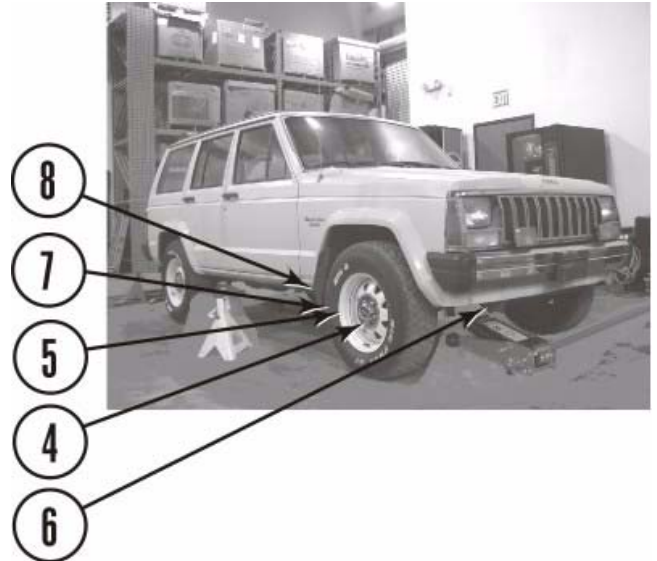

**D. Get ready to install rear axle shackle lifts.**

1. Lift rear axle.

- a. Using a hydraulic jack, slowly lift rear axle (31) so that two rear tires (32) are three to five inches off of ground. Position jack stands under frame (8) just in front of leaf spring perches (33). Lower frame onto jack stands. Do not remove hydraulic jack pressure from axle.
- b. Remove two nuts (34), washers (35), and shocks (36) from rear axle (31).

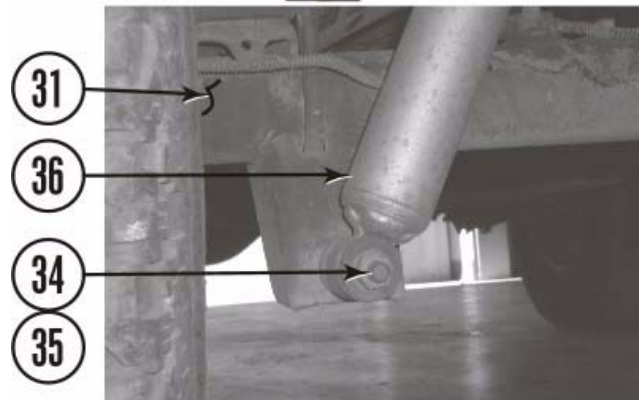

2. Remove rear passenger side shackle hardware.
  - a. Adjust rear axle (31) to release pressure from leaf springs (37) and shackles (38). Do not lift vehicle off of jack stands.
  - b. Remove nut (39) and bolt (40) from shackle (38) and leaf spring (37).
  - c. Remove bolt (41) and shackle (38) from frame (8).

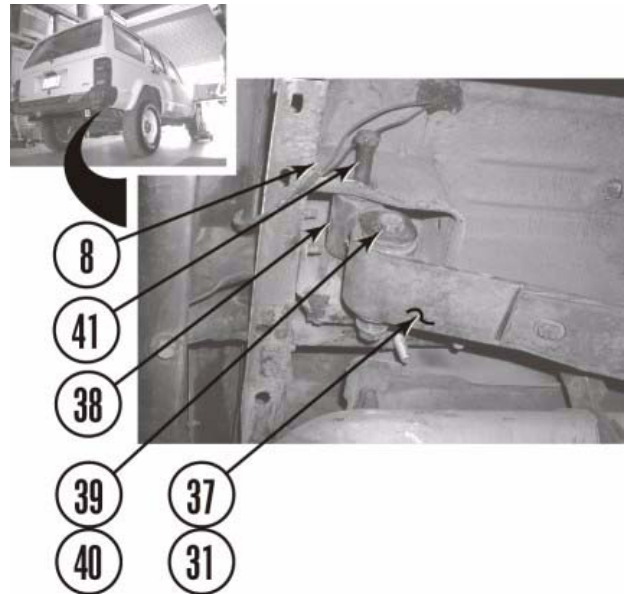

3. Install *kit* lift shackle passenger side.
  - a. Install *kit* shackle (42) on frame (8) with bolt (41).
  - b. Align rear axle (31) and leaf spring (37) with *kit* shackle (42). Install leaf spring on *kit* lift shackle with bolt (40) and nut (39).
  - c. Tighten bolts (40 and 41) and nut (39) to manufacturer recommended specifications.

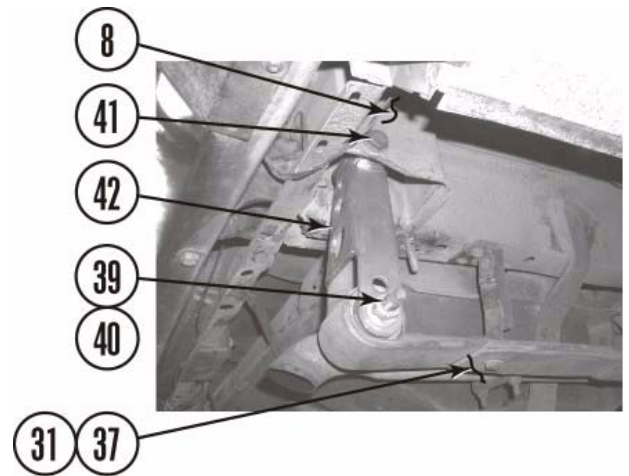

4. Install *kit* lift shackle driver side.
  - a. Repeat steps D.2.a. through D.3.c. for driver side rear axle (31).
  - b. If necessary, lift rear axle (31) and install two shocks (36) on rear axle with two washers (35) and nuts (34).

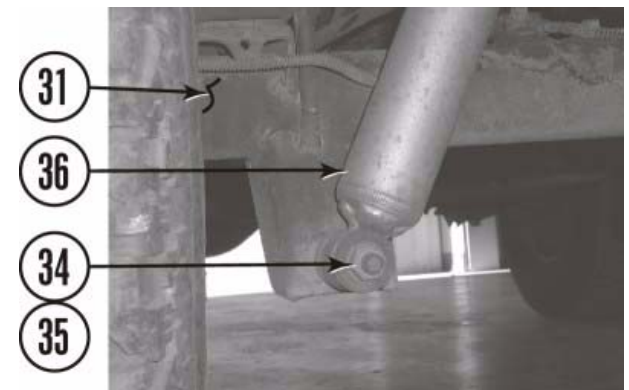

## E. Finish the kit.

1. Finish rear axle.
  - a. Using a hydraulic jack, slowly lift rear axle (31) high enough to remove jack stands. Remove jack stands from frame (8). Lower vehicle to ground.



2. Connect both battery cables.
  - a. Connect the positive cable (2) first, then the negative cable (1) to the battery (3).
3. Double check the vehicle.

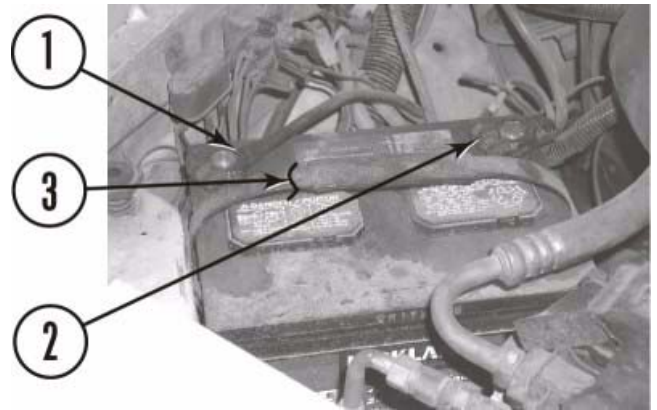

**⚠CAUTION**

Retorque all fasteners after 500 miles and after off road use. All coil spring lift components should be visually inspected and fasteners retorqued during routine vehicle servicing.

- a. Check all mounting hardware to ensure it is properly tightened.
- b. Check the operation of the brakes and the parking brake. Check brake lines for adequate travel. Ensure brake lines do not touch any surfaces, moving or otherwise. If necessary, adjust brake lines and or brake line bracketery to eliminate all contact.
- c. Ensure that all OEM or aftermarket bump stops are installed. Suspension over travel can result in serious damage or failure of OEM components and aftermarket equipment.
- d. Test drive vehicle in all gears and 4 wheel drive ranges. Pay close attention to all vehicle systems. Check all hardware again in 500 miles and as part of your regular maintenance schedule.

**F. 2" Coil Spring / Shackle Lift Kit Parts List.**

Callout	Quantity	Description
(30)	2	Bump stop bushings
(29)	2	2" coil spacer lift bushing
(42)	2	Shackles
	1	6ml bottle Loctite
	1	warning sticker
	1	logo sticker

**⚠CAUTION**

Performance Automotive Group does not recommend any particular wheel and tire combinations for use with its suspension lifts and cannot assume responsibility for the customer's choice of wheels and tires. Reference your owner's manual for recommended tire sizes and warnings related to the use of oversized tires. Larger wheel and tire combinations increase stress and wear on steering and suspension components, which leads to increased maintenance and higher risk for component failure. Larger wheel and tire combinations also alter speedometer calibration, braking effectiveness, center of gravity, and handling characteristics. Consult with an experienced local off road shop to find what wheel and tire combinations work best with your vehicle.

**⚠NOTE**

All warranty information, instruction sheets, and other documents regarding the installation of this product must be retained by the vehicle owner. Information contained in the instructions and on the warranty card will be required for any warranty claims. The vehicle owner needs to understand the modifications made to his vehicle and how they affect vehicle handling and performance. Failure to provide the customer with this information can result in damage to the vehicle and severe personal injury.